

TOLERANCES (UNLESS SPECIFIED)	
0-10mm	±0.2mm
10.1-50mm	±0.5mm
50.1-250mm	±1.0mm
>250mm	±2.0mm

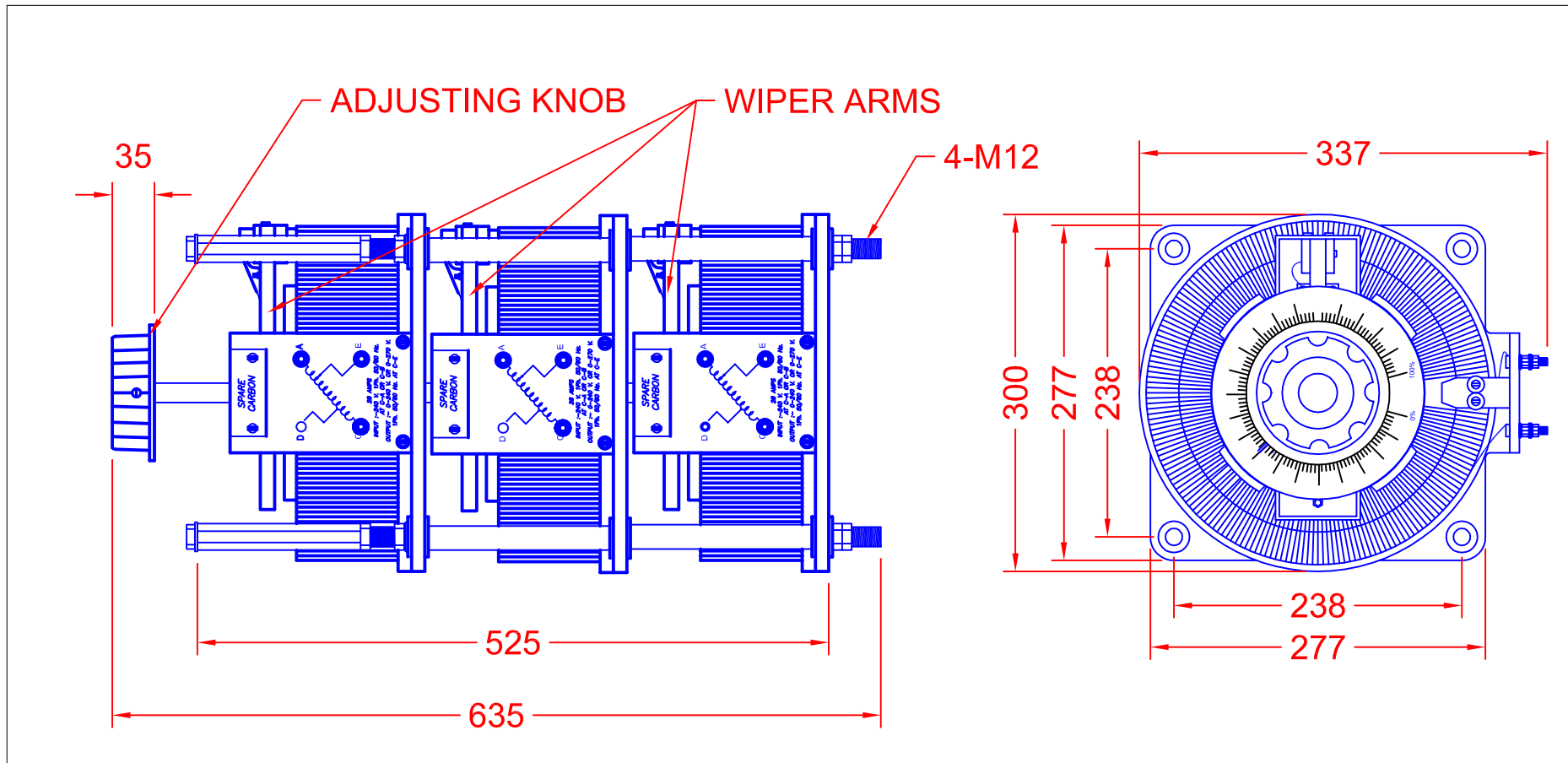

VARIAC

MODEL CMV28F-3  
 INPUT 415V  
 OUTPUT 1 0-100%  
 OUTPUT 2 0-112%  
 RATED 28 AMPS

TERMINATIONS M6 STUDS

- A LIVE I/P FOR 100% O/P
- B LIVE I/P FOR 112% O/P
- C NEUTRAL I/P AND O/P
- D CENTRE TAP (FOR BUCK-BOOST)
- E LIVE O/P (VARIABLE)

REV	
4	
3	
2	
1	

**CARROLL & MEYNELL**  
 TRANSFORMERS LIMITED  
 TEL: 01642 617406 FAX: 01642 614178  
 enquiries@carroll-meynell.com

TITLE
3PH VARIAC CMV28F-3
ALL DIMENSIONS IN mm

DRAWN	PROJECTION	DATE	SCALE
SH		29/5/8	NTS
DRAW No	REV	PAGE	
6098	0	1/1	