

TOLERANCES (UNLESS SPECIFIED)	
0-10mm	±0.2mm
10.1-50mm	±0.5mm
50.1-250mm	±1.0mm
>250mm	±2.0mm

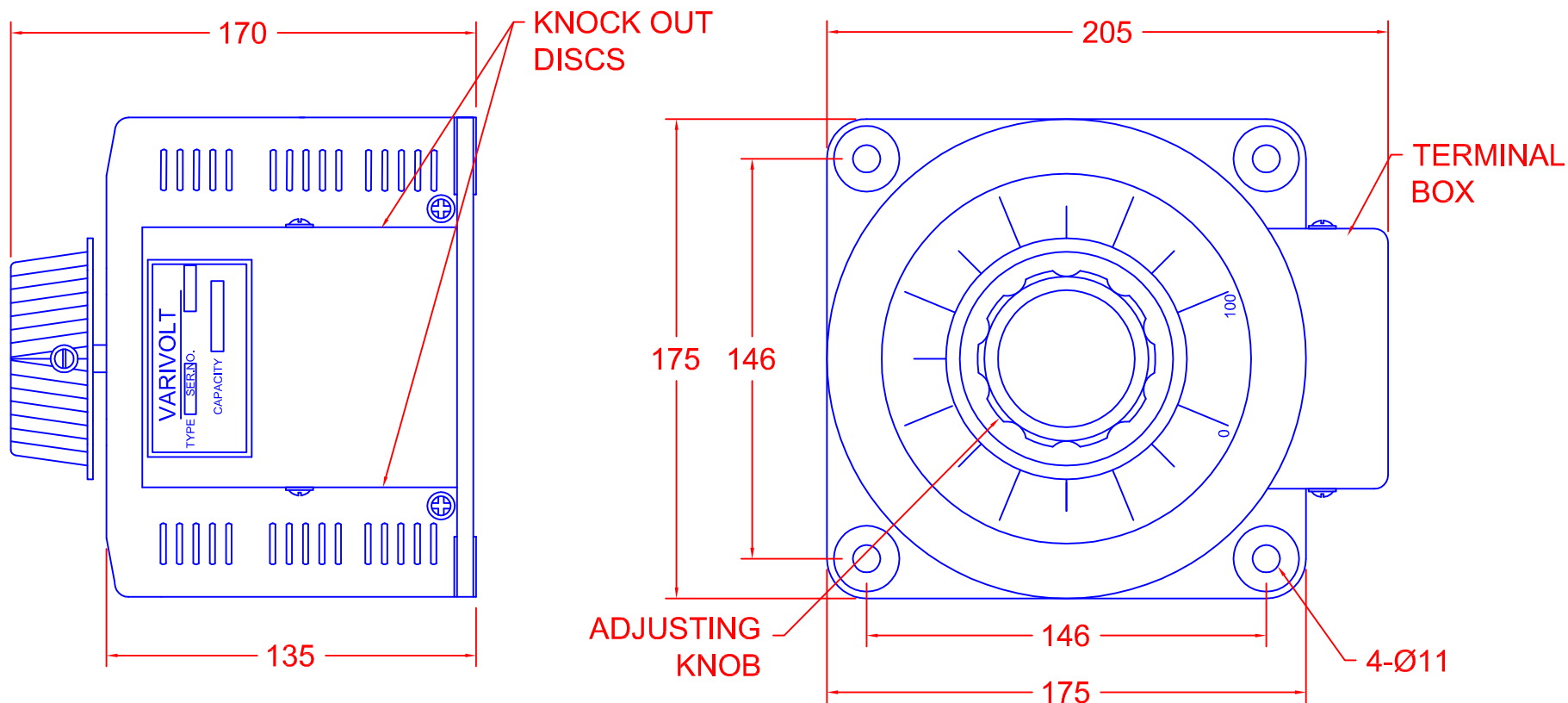

VARIAC

MODEL CMV8E-1
 INPUT 240V
 OUTPUT 1 0-100%
 OUTPUT 2 0-112%
 RATED 8 AMPS

TERMINATIONS M4 STUDS

- A LIVE I/P FOR 100% O/P
- B LIVE I/P FOR 112% O/P
- C NEUTRAL I/P AND O/P
- D CENTRE TAP (FOR BUCK-BOOST)
- E LIVE O/P (VARIABLE)

REV	
4	
3	
2	
1	

CARROLL & MEYNELL
 TRANSFORMERS LIMITED
 TEL: 01642 617406 FAX: 01642 614178
 enquiries@carroll-meynell.com

TITLE
**SPH VARIAC
 CMV8E-1**
 ALL DIMENSIONS IN mm

DRAWN	PROJECTION	DATE	SCALE
SH		30/4/8	NTS
DRAW No	REV	PAGE	
6079	0	1/1	